

# Reducer

## Metric to Metric Thread

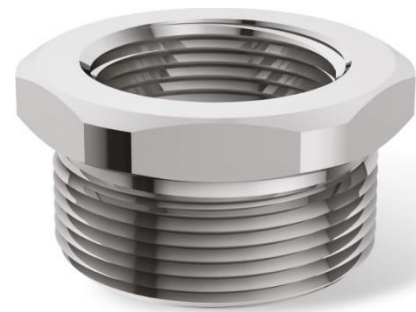

### MM-EX-RD3M1M X6 (M32 to M20)



#### Reducer

<b>IP Rating</b>	IP68
<b>IECEx Certificate No.</b>	IECEx PRE 20.0123X
<b>ATEX Certificate No.</b>	Presafe 20 ATEX 24571X
<b>EAC Certificate No.</b>	RU C-IN.AA71.B.00212/20
<b>PESO Certificate No.</b>	P538496/1
<b>Thread Type</b>	Metric to Metric
<b>Protection Type</b>	Ex d, Ex e, Ex t
<b>Material</b>	Stainless Steel (SS316L)
<b>Ambient Temperature</b>	IECEx/ATEX-55°C ≤ Ta ≤ +160°C EAC-60°C ≤ Ta ≤ +130°C

#### Metric to Metric Thread

<b>CODE</b>	MM-EX-RD3M1M X6 (M32 to M20)
<b>A</b>	M32X1.5
<b>B</b>	M20X1.5
<b>L</b>	22
<b>A/F</b>	36
<b>G</b>	16

\* Degrees of protection (IP Code) : IP66 / IP68 (1.5 meter, 2 Hours)