

Adaptor

Metric to Metric

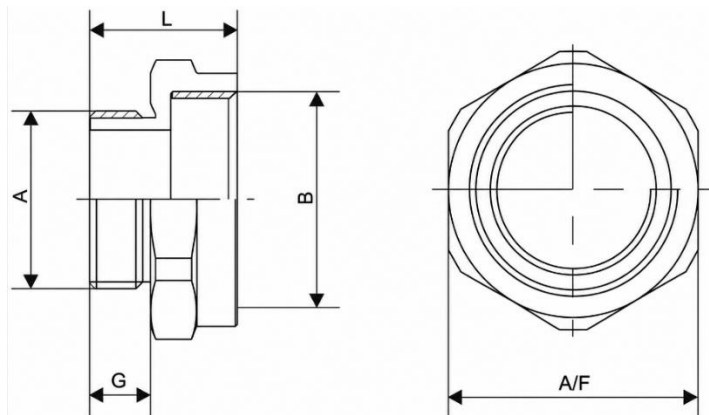

MM-EX-AD6M6M X6 (M63 to M63)



Reducer

IP Rating	IP68
IECEX Certificate No.	IECEX PRE 20.0123X
ATEX Certificate No.	Presafe 20 ATEX 24571X
EAC Certificate No.	RU C-IN.AA71.B.00212/20
PESO Certificate No.	P538496/2
Thread Type	Metric to Metric
Protection Type	Ex d, Ex e, Ex t
Material	Stainless Steel (SS316L)
Ambient Temperature	IECEX/ATEX-55°C ≤ Ta ≤ +160°C EAC-60°C ≤ Ta ≤ +130°C

Metric to Metric Thread

CODE	MM-EX-AD6M6M X6 (M63 to M63)
A	M63X1.5
B	M63X1.5
L	34
A/F	16
G	68

* Degrees of protection (IP Code) : IP66 / IP68 (1.5 meter, 2 Hours)