

Adaptor

Metric to NPT

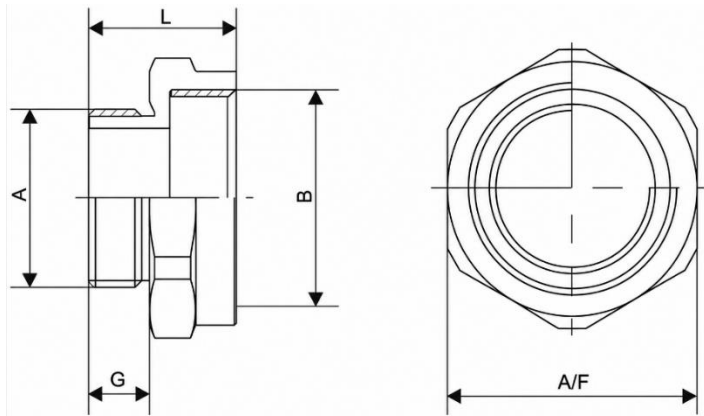

MM-EX-AD1M2N X6 (M20 to 3/4"NPT)



Reducer

IP Rating	IP68
IECEX Certificate No.	IECEX PRE 20.0123X
ATEX Certificate No.	Presafe 20 ATEX 24571X
EAC Certificate No.	RU C-IN.AA71.B.00212/20
PESO Certificate No.	P538496/2
Thread Type	Metric to NPT
Protection Type	Ex d, Ex e, Ex t
Material	Stainless Steel (SS316L)
Ambient Temperature	IECEX/ATEX-55°C ≤ Ta ≤ +160°C EAC-60°C ≤ Ta ≤ +130°C

Metric to NPT Thread

CODE MM-EX-AD1M2N X6 (M20 to 3/4"NPT)

A	M20X1.5
B	3/4"
L	37
A/F	16
G	30

* Degrees of protection (IP Code) : IP66 / IP68 (1.5 meter, 2 Hours)